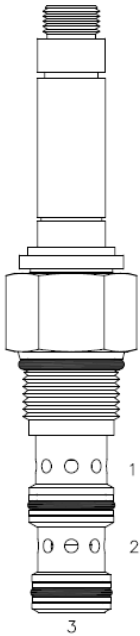

**HTU-S3E DIRECT ACTING SPOOL, 3 WAY 2 POSITION, HIGH PRESSURE**

**DESCRIPTION**

"High Pressure" 12 size, 1 1/16-12 thread, "Twelve" series, solenoid operated, 3 way 2 position, spool valve

**OPERATION**

When de-energized the HTU-S3E allows flow from (2) to (1) and blocks flow at port (3). When energized the valve allows flow from (3) to (2) and blocks flow at port (1).

**FEATURES**

- Hardened parts for long life.
- Efficient wet-armature construction.
- Cartridges are voltage interchangeable.
- Industry common cavity.
- Unitized, molded coil design.
- Continuous duty rated solenoid.
- Optional coil voltages and terminations.
- Optional "I" Coil: Weatherproof, Thermal Shock, Immersion Safe

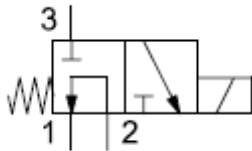
**HYDRAULIC SYMBOL**

Common usage is inlet at port (3).  
See HTU-S3F for port (2) or port (1) inlet.

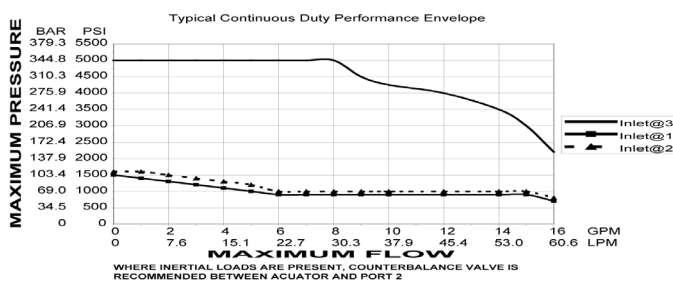
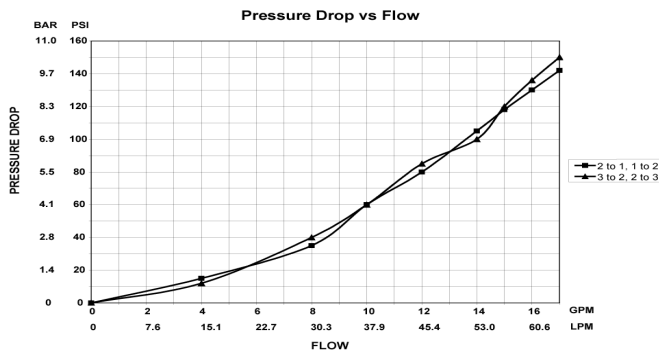
**PERFORMANCE**
**Actual Test Data (Cartridge Only)**

**VALVE SPECIFICATIONS**

Nominal Flow	15 GPM (57 LPM)
Rated Operating Pressure	5000 PSI (345 bar)
Typical Internal Leakage (150 SSU)	15 cu in/min (246 ml/min) per path
Viscosity Range	36 to 3000 SSU (3 to 647 cSt)
Filtration	ISO 18/16/13
Media Operating Temperature Range	-40° to 250° F (-40° to 120° C)
Weight	1.01 lbs. (0.46 kg)
Operating Fluid Media	General Purpose Hydraulic Fluid
Cartridge Torque Requirements	90 ft-lbs (122 Nm)
Coil Nut Torque Requirements	5-7 ft-lbs (6.8-9.5 Nm)
Cavity	<b>TWELVE 3W</b>
Cavity Form Tool (Finishing)	40500034
Seal Kit	21191305

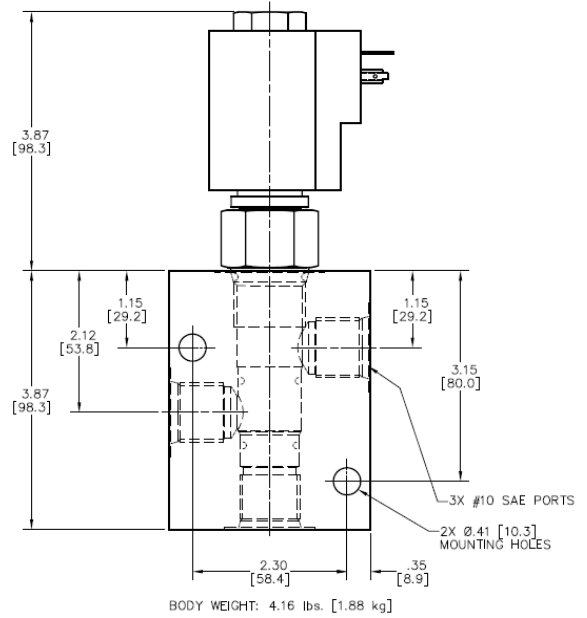
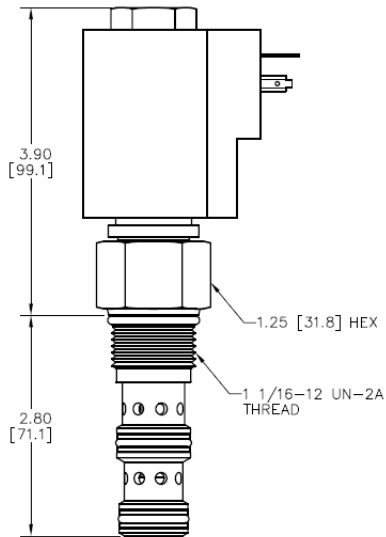
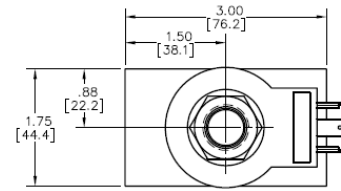
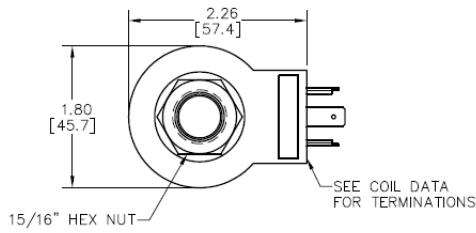
**DIMENSIONS**



**ORDERING INFORMATION**

**HTU-S3E**

**OPTIONS**

Buna Standard **00**  
 Viton Standard **V0**

Blank **S**  
 #10 SAE Ports

**"T" COIL TERMINATION**

(All DC Except as Noted)

Double Lead **DL**  
 Deutsch on Leads **DT**  
 Metri-Pack on Leads **ML**  
 Packard on Leads **PL**  
 Weatherpak on Leads **WL**  
 Double Spade **DS**  
 DIN 43650 (Hirschman) – (AC/DC) **HC**

**IMMERSION PROOF "T" TYPE**

**IA** "I" Coil AMP Superseal - Integral  
**ID** "I" Coil Deutsch – Integral DT04-2P

**VOLTAGE**

**06** 6 VDC  
**12** 12 VDC  
**24** 24 VDC  
**36** 36 VDC  
**48** 48 VDC  
**25** 24 VAC  
**11** 120 VAC  
**22** 220 VAC

Approximate Coil Weight: .89 lbs/.41 kg.

**WARNING:** the specifications/application data shown in our catalogs and data sheets are intended only as a general guide for the product described (herein). Any specific application should not be undertaken without independent study, evaluation, and testing for suitability.